

MAQUINOTEL

asdor

SINCE 1970

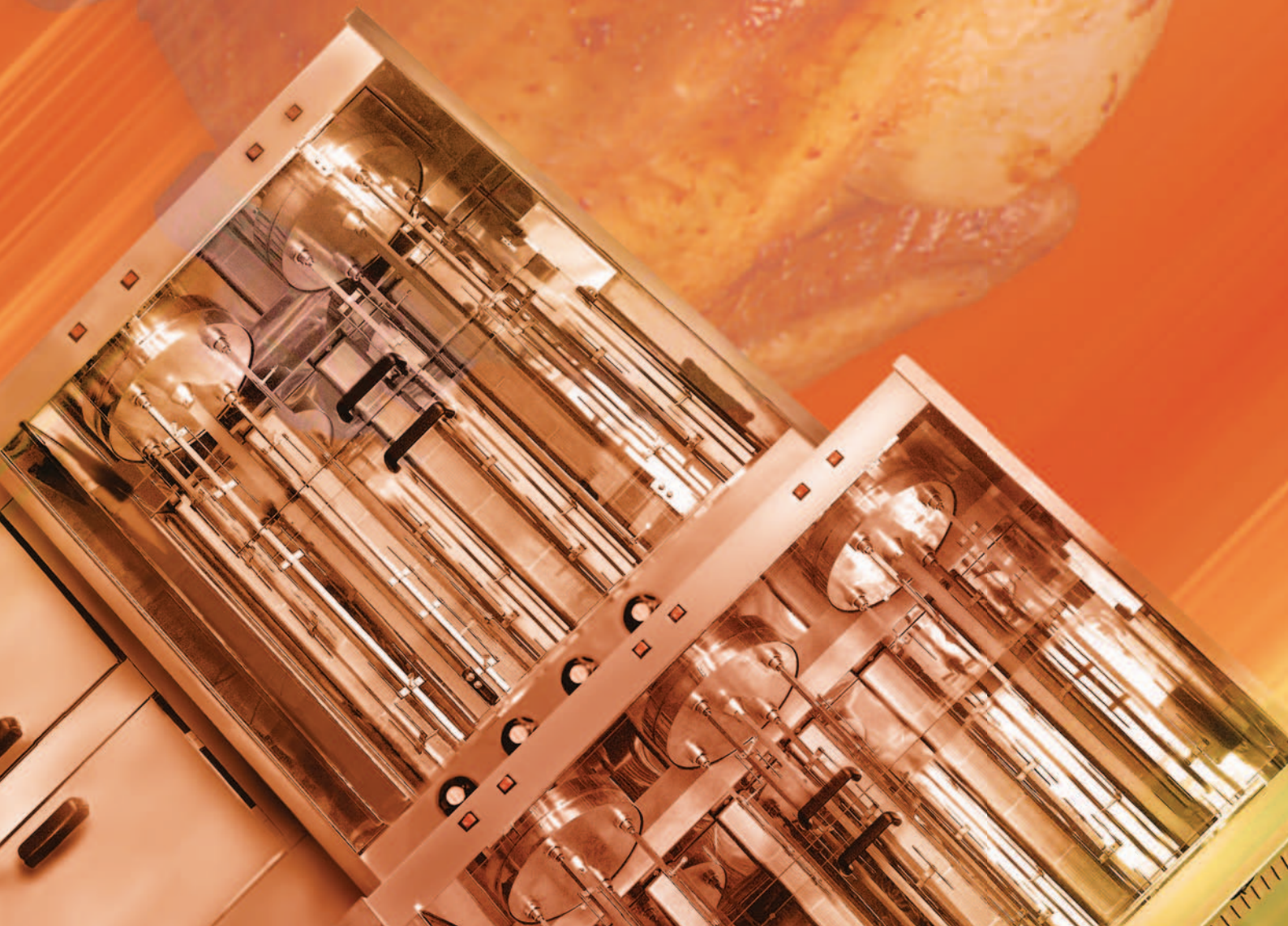

¿QUIÉNES SOMOS?

MAQUINOTEL ASDOR S.L., empresa fundada en el año 1967, a través de los años hemos ido ampliado nuestro catálogo por las exigencias marcadas por las necesidades de nuestros clientes. Todos estos años dedicados a la fabricación de nuestros aparatos nos sirven para poder ofrecer una gran experiencia y conocimiento de nuestros fabricados. Siempre teniendo en cuenta la máxima calidad y servicio para que nuestros clientes estén satisfechos.

El catálogo de Asdor se compone de una extensa gama de asadores verticales, doble espada, planetarios, espada regulable, leña, así como de planchas snack, vitrinas calefactoras y mesa bandeja. Asdor ofrece la posibilidad a sus clientes de hacer alguna modificación a los asadores siempre bajo petición y aprobación técnica.

Todos los aparatos Asdor cada año pasan los controles exigidos por el Ministerio de Industria y Comercio para mantener el mercado CE.

MAQUINOTEL ASDOR SL was founded in 1967 and we have expanded our catalogue following the feedback and needs of our customers.

Our 44 years dedicated to manufacturing machinery has given us a wealth of experience and knowledge in our field of products, always considering the best quality and service to make sure that our customers are satisfied.

The Asdor catalogue consists of a wide range of vertical grills, planetarium grills, wood burning grills, double sword grills, adjustable blade grills, and hot plates, hot cabinets and table heating trays.

On request Asdor offers its customers the possibility to custom manufacture a grill or grills to their own requirements, after a technical approval of the design.

All Asdor appliances pass the inspections required by the Ministry of Industry and Commerce each year to maintain the CE mark.



Stand de ASDOR en Hostelco Barcelona (Spain)

ÍNDICE

Asadores espada simple	4
Asadores doble espada	8
Asadores planetarios	12
Asadores espadas regulables	14
Asadores de leña	18
Vitrinas calefactoras y expositoras	20
Mesa con bandeja	21
Gratinadora Salamandra	21
Planchas snack	22

GARANTÍA

Todos los aparatos de Maquinotel ASDOR S.L. estan garantizados conforme al R.D. legislativo 1/2007 de 16 de noviembre

ASADORES ESPADA SIMPLE



mod. R-6

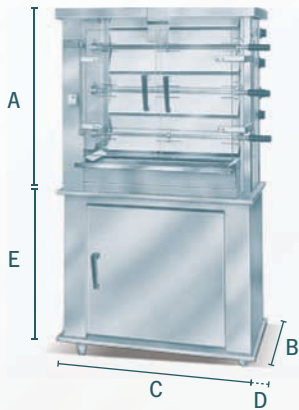
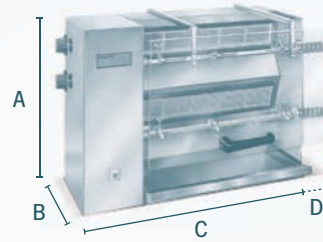

mod. R-12



mod. R-24

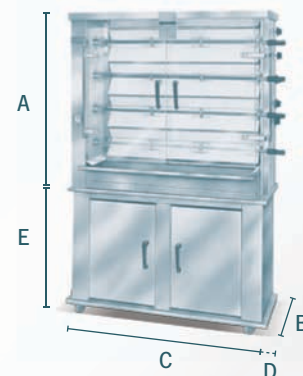

ASADORES ESPADA SIMPLE

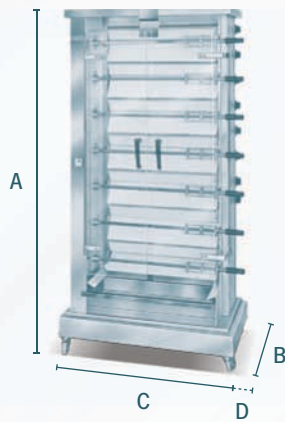

mod. R-28



mod. R-42

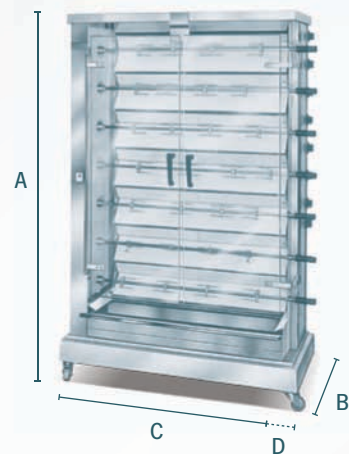

ASADORES ESPADA SIMPLE



mod. R-56

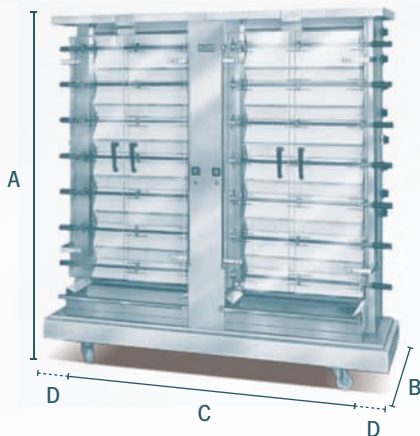



mod. R-84

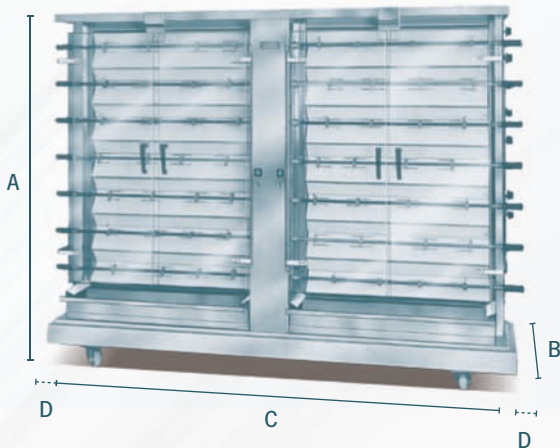

ASADORES ESPADA SIMPLE

Modelo	Capacidad (unidades)	Alto (A) (mm)	Fondo (B) (mm)	Ancho (C) (mm)	Ancho máx. (D)* (mm)	Mesa (E) (mm)	Espadas (unidades)	Mesa opcional	Comentarios
R-6	4-6	485	270	665	-	-	2	-	A rayos infrarrojos con butano, propano, gas natural y eléctrico
R-12	12	850	450	870	+200	790	3	Sí	A rayos infrarrojos con butano, propano, gas natural y eléctrico
R-24	24	1.050	450	1.170	+200	790	4	Sí	A rayos infrarrojos con butano, propano, gas natural y eléctrico
R-28	28	1.810	450	870	+200	-	7	-	A rayos infrarrojos con butano, propano, gas natural y eléctrico
R-42	42	1.810	450	1.170	+200	-	7	-	A rayos infrarrojos con butano, propano, gas natural y eléctrico
R-56	56	1.810	450	1.740	+400	-	14	-	A rayos infrarrojos con butano, propano, gas natural y eléctrico
R-84	84	1.810	450	2.340	+400	-	14	-	A rayos infrarrojos con butano, propano, gas natural y eléctrico

*Espacio máximo necesario con mangos y puertas abiertas

Fabricados con un motor para toda la transmisión, con posibilidad de fabricar un motor por espada.

Consultar otras posibles opciones de medidas y motores.

ASADORES DOBLE ESPADA

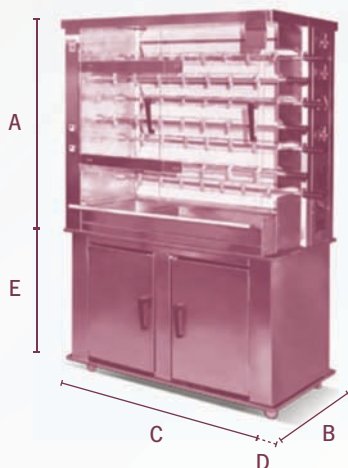
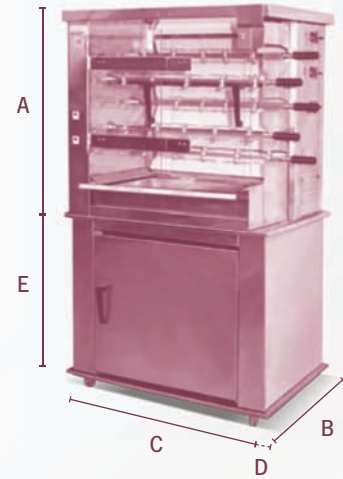

ASADORES DOBLE ESPADA



mod. R-520



mod. R-780

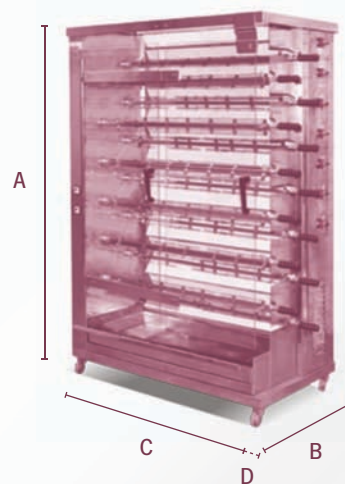

ASADORES DOBLE ESPADA

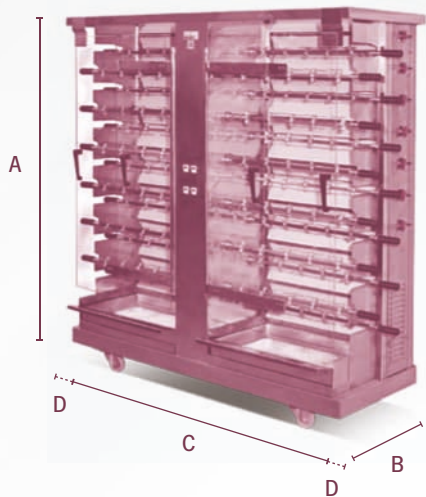

mod. R-1040



mod. R-1560

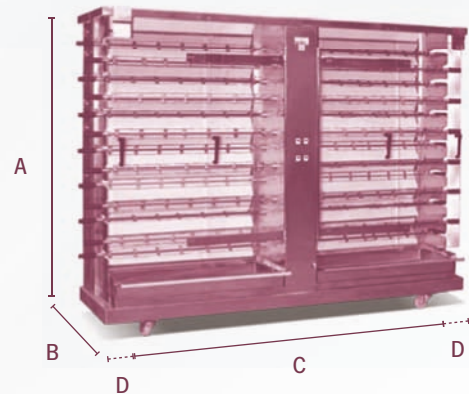

ASADORES DOBLE ESPADA

Modelo	Capacidad (unidades)	Alto (A) (mm)	Fondo (B) (mm)	Ancho (C) (mm)	Ancho máx. (D)* (mm)	Mesa (E) (mm)	Espadas (unidades)	Mesa opcional	Comentarios
R-200	20	850	610	870	-	790	5	Si	A rayos infrarrojos con butano, propano, gas natural y eléctrico
R-390	42	1.050	610	1.170	+110	790	7	Si	A rayos infrarrojos con butano, propano, gas natural y eléctrico
R-520	52	1.810	610	870	+110	-	13	-	A rayos infrarrojos con butano, propano, gas natural y eléctrico
R-780	78	1.810	610	1.170	+110	-	13	-	A rayos infrarrojos con butano, propano, gas natural y eléctrico
R-1040	104	1.810	610	1.740	+200	-	26	-	A rayos infrarrojos con butano, propano, gas natural y eléctrico
R-1560	156	1.810	610	2.340	+200	-	26	-	A rayos infrarrojos con butano, propano, gas natural y eléctrico

*Espacio máximo necesario con mangos y puertas abiertas

ASADORES PLANETARIOS



mod. RP-20

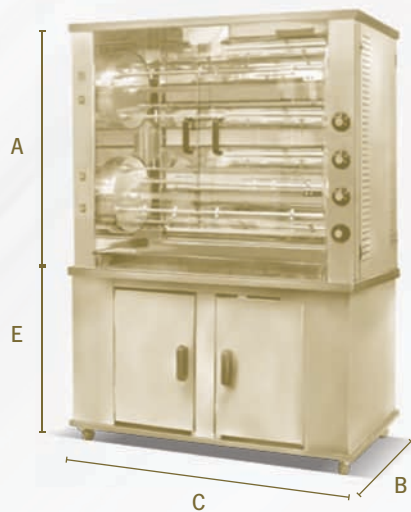
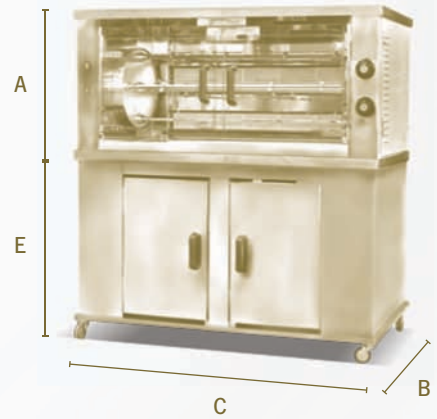

mod. RP-40





mod. RP-60

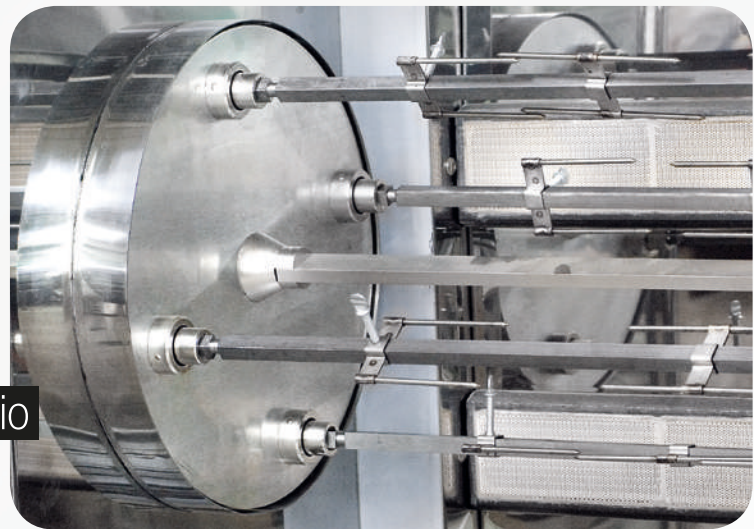

Detalle planetario

ASADORES PLANETARIOS

Modelo	Capacidad (unidades)	Alto (A) (mm)	Fondo (B) (mm)	Ancho (C) (mm)	Ancho máx. (D)* (mm)	Mesa (E) (mm)	Espadas (unidades)	Mesa opcional	Comentarios
RP-20	20	620	695	1.285	-	1.035	4	Sí	A rayos infrarojos con butano, propano, gas natural y eléctrico
RP-40	40	1.085	695	1.285	-	781	8	Sí	A rayos infrarojos con butano, propano, gas natural y eléctrico
RP-60	60	1.750	695	1.285	-	-	12	-	A rayos infrarojos con butano, propano, gas natural y eléctrico

*Espacio máximo necesario con mangos y puertas abiertas

ASADORES ESPADAS REGULABLES



mod. AM-24

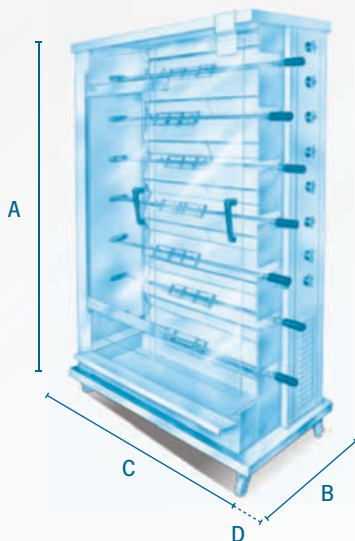
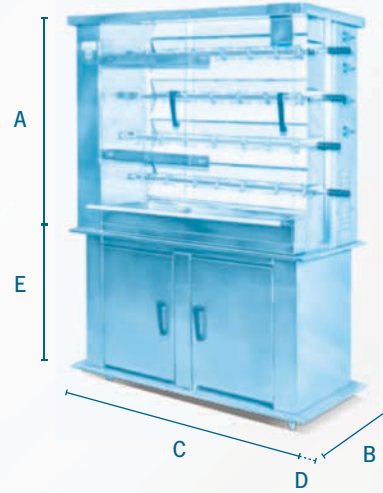

mod. AM-42



ASADORES ESPADAS REGULABLES

15

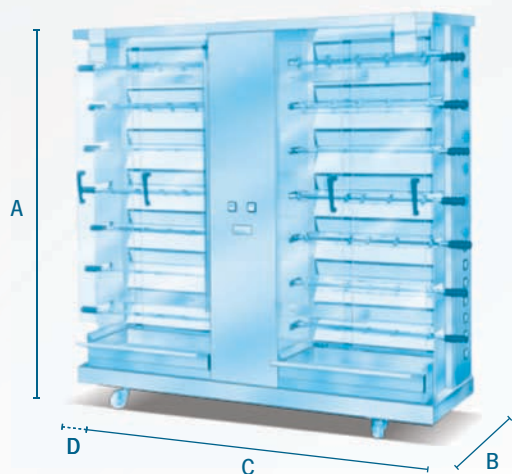

mod. AM-56



Detalle espadas regulables

ASADORES ESPADAS REGULABLES

Modelo	Capacidad (unidades)	Alto (A) (mm)	Fondo (B) (mm)	Ancho (C) (mm)	Ancho máx. (D)* (mm)	Mesa (E) (mm)	Espadas (unidades)	Mesa opcional	Comentarios
AM-12	12	1.620	560	920	+110	790	3	Sí	A rayos infrarrojos con butano, propano y gas natural
AM-24	24	1.840	560	1.265	+110	790	4	Sí	A rayos infrarrojos con butano, propano y gas natural
AM-28	28	1.830	560	920	+110	-	7	-	A rayos infrarrojos con butano, propano y gas natural
AM-42	42	1.830	560	1.265	+110	-	7	-	A rayos infrarrojos con butano, propano y gas natural

*Espacio máximo necesario con mangos y puertas abiertas



Espada jaula

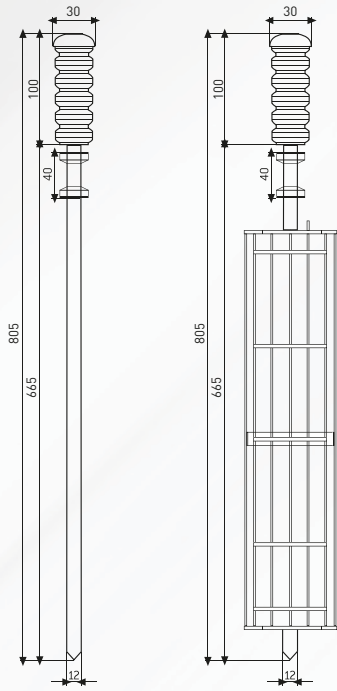

Espada corta

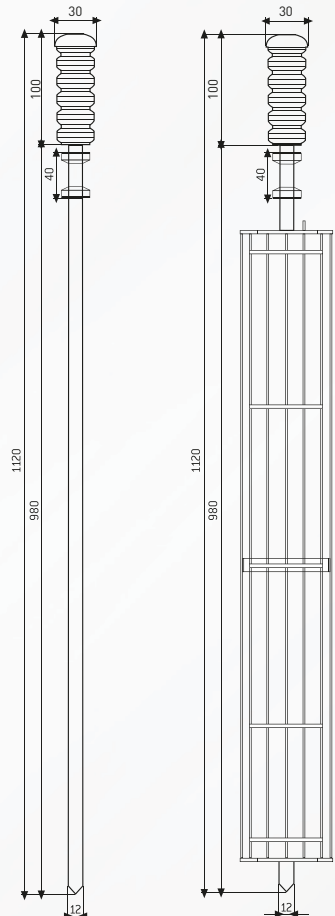

Espada larga

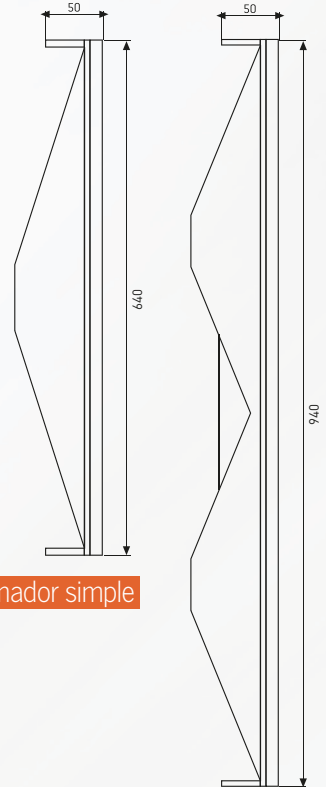

Quemador simple

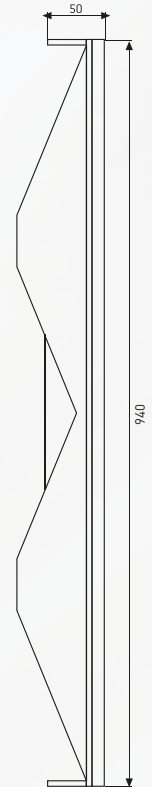

Quemador doble

*Medidas en milímetros

La dotación inicial de pinchos por espada es de:

Espada corta Dos sencillos y uno doble / **Espada larga** Dos sencillos y dos dobles

ASADORES PARA CAMIONES Y REMOLQUES

Asadores montados en remolques y camiones para la venta ambulante.

Posible montaje a 220 v., 12 v. o 24 v.

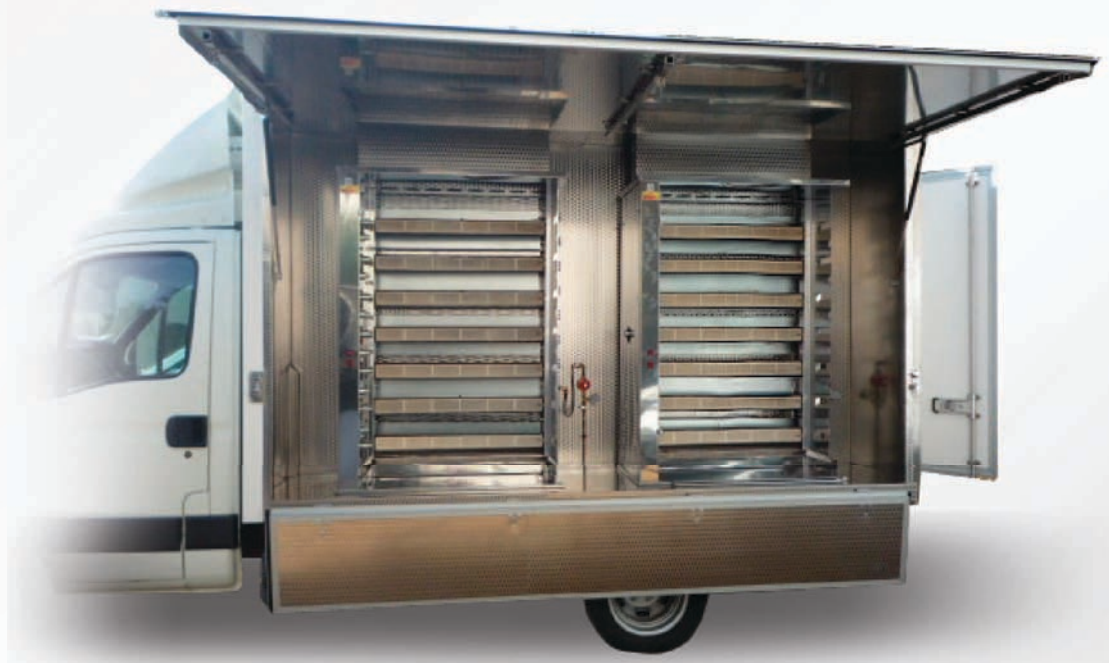

ASADORES DE LEÑA

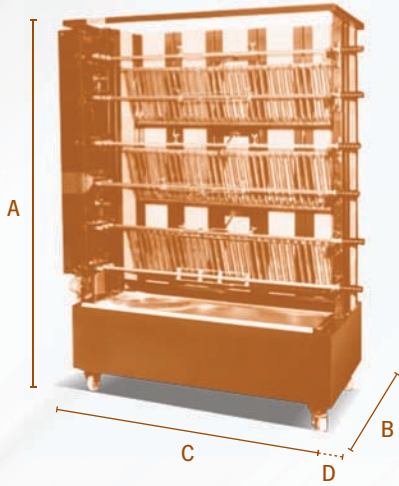

Detalle

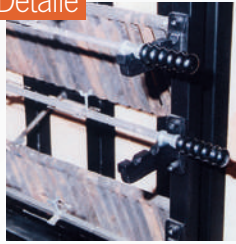

mod. AL-360



Detalle



mod. AL-480

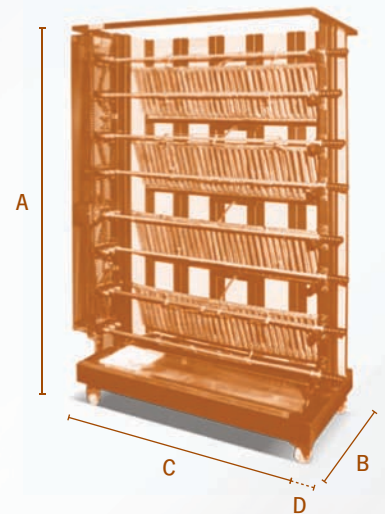

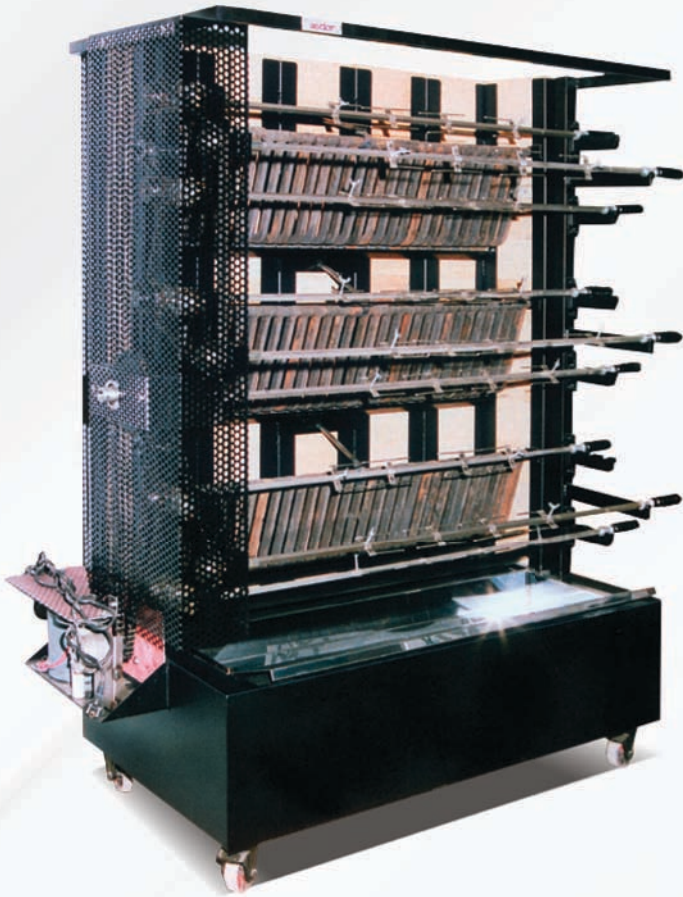

Detalle

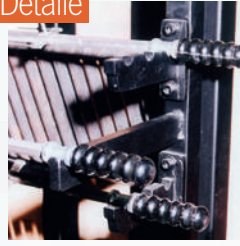

mod. AL-540
Doble espada

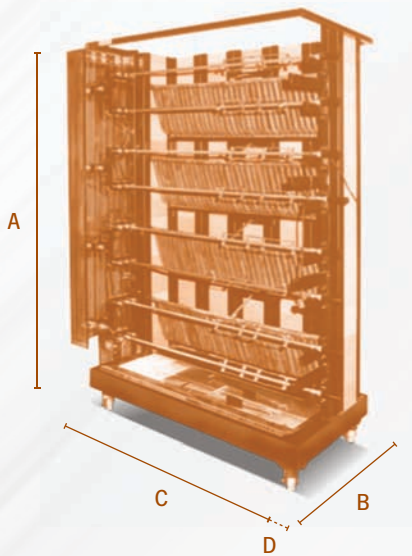
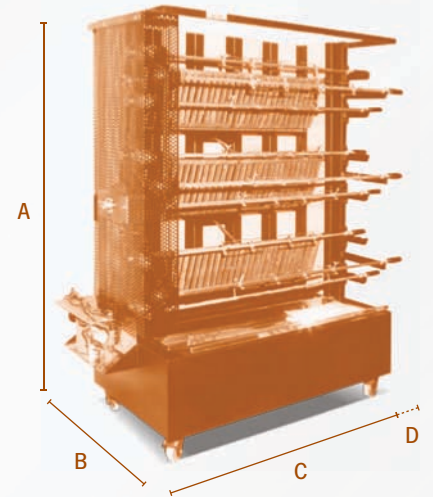

Detalle



mod. AL-720
Doble espada



ASADORES DE LEÑA

Modelo	Capacidad (unidades)	Alto (A) (mm)	Fondo (B) (mm)	Ancho (C) (mm)	Ancho máx. (D)* (mm)	Espadas (unidades)	Mesa opcional
AL-360	36	1.730	900	1.540	-	6	-
AL-480	48	1.930	900	1.540	-	8	-
AL-360 DOBLE ESPADA	54	1.730	900	1.540	-	9	-
AL-480 DOBLE ESPADA	72	1.930	900	1.540	-	12	-

*Espacio máximo necesario con mangos y puertas abiertas

VITRINAS CALEFACTORAS Y EXPOSITORAS



mod. AC-60



mod. AC-60 B



VITRINAS

Modelo	Alto (A) (mm)	Alto Interior (mm)	Fondo (B) (mm)	Fondo Interior (mm)	Ancho (C) (mm)	Ancho Interior (mm)
AC-60	935	695	445	395	1.040	975
AC-60B	955	695	445	395	1.040	975

MESA / BANDEJA

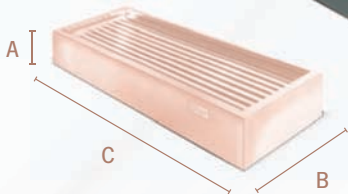

mod. MT



mod. MB-240

MESA / BANDEJA

Modelo	Alto (A) (mm)	Fondo (B) (mm)	Ancho (C) (mm)
MB-240	970	440	1.165
MT	175	400	1.120

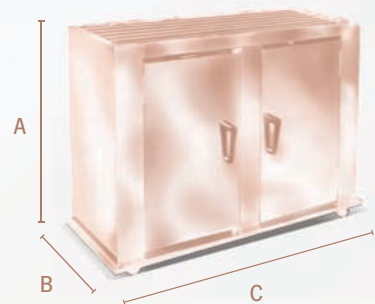

GRATINADORA SALAMANDRA



mod. G/A-60

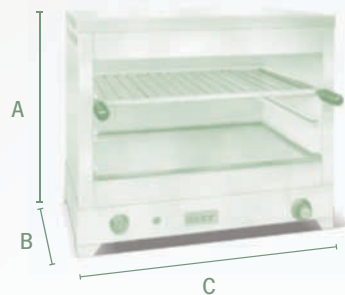

GRATINADORA SALAMANDRA

Modelo	Alto (A) (mm)	Alto Interior (mm)	Fondo (B) (mm)	Fondo Interior (mm)	Ancho (C) (mm)	Ancho Interior (mm)
G/A-60	610	310	455	450	735	650

PLANCHAS SNACK



mod. PL-500



mod. PL-750

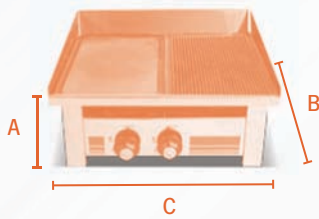

mod. PL-1000

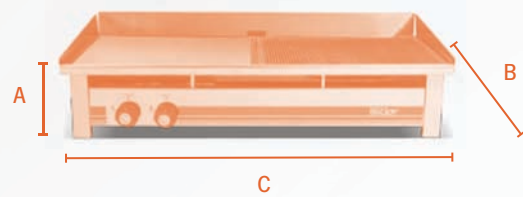

mod. PL-1250

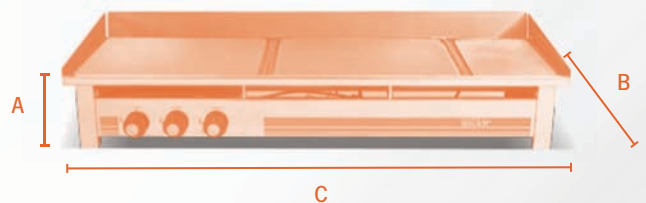



mod. PFO-500



mod. PFO-750

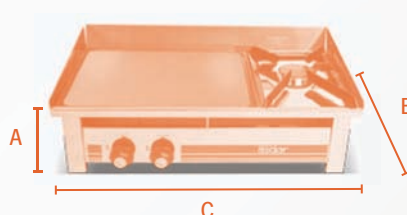

mod. PFO-1000



mod. PFO-1250

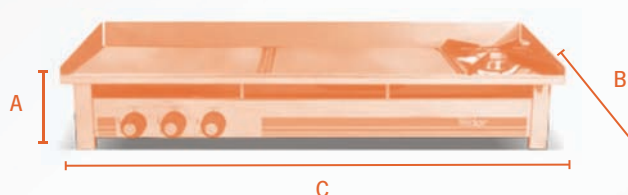

PLANCHAS SNACK

Modelo	Alto (A) (mm)	Fondo (B) (mm)	Ancho (C) (mm)
PL-500	200	420	505
PL-750	200	420	755
PL-1000	200	420	1.005
PL-1250	200	420	1.255

Modelo	Alto (A) (mm)	Fondo (B) (mm)	Ancho (C) (mm)
PFO-500	200	420	505
PFO-750	200	420	755
PFO-1000	200	420	1.005
PFO-1250	200	420	1.255



MAQUINOTEL

asdor

Fábrica y Oficinas:

C/ Cot, 47, Polígono Cadesbank

Tel. +34 93 692 18 85 · Fax +34 93 692 52 47 · asdorsl@gmail.com

08291 RIPOLLET (Barcelona) - SPAIN

www.asdor.es